

PRODUCT CODE: HH1030
HEXAGON SET SCREW

DESCRIPTION

M10 x 30mm Hexagon Set Screw

FINISH

BZP

MATERIAL

HT8.8 Steel

PACKAGING

Packed in qty 100

ADDITIONAL NOTES

Manufactured from High Tensile Steel Grade 8.8

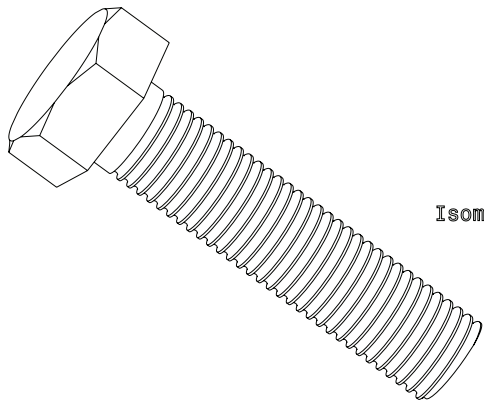
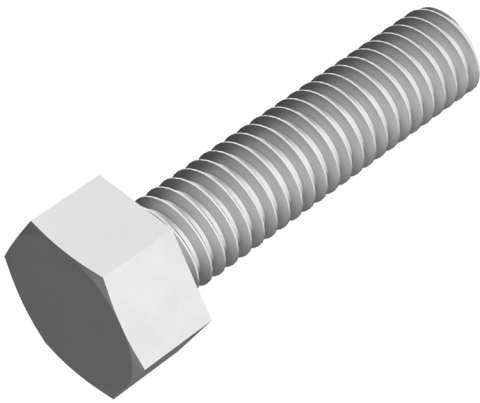

Isometric view

	LENGTH IN MM											
	10	12	16	20	25	30	35	40	50	60	80	100
M6	HH610	HH612	HH616	HH620	HH625	HH630	HH635	HH640	HH650	-	-	-
M8	HH810	HH812	HH816	HH820	HH825	HH830	HH835	HH840	HH850	-	-	-
M10	-	-	-	HH1020	HH1025	HH1030	HH1035	HH1040	HH1050	HH1060	HH1080	HH10100
M12	-	-	-	HH1220	HH1225	HH1230	HH1235	HH1240	HH1250	HH1260	HH1280	HH12100
M16	-	-	-	-	HH1625	HH1630	HH1635	HH1640	HH1650	HH1660	HH1680	HH16100
M20	-	-	-	-	-	-	-	-	-	-	HH2080	HH20100